

Exterior spherical bearing housing

Upright UCP300 with top wire-UCP313

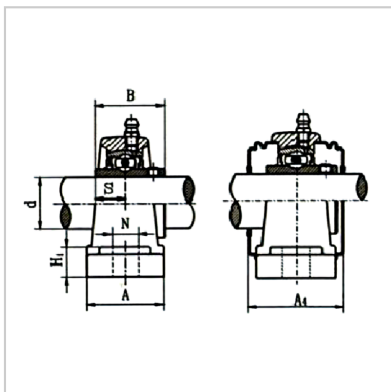
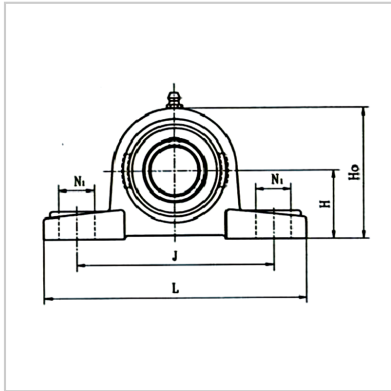
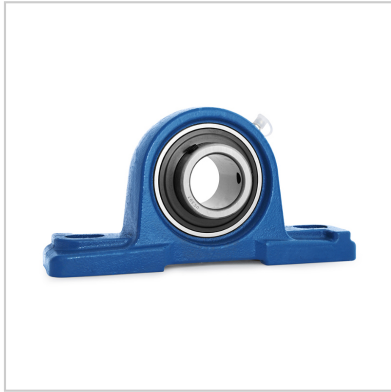

Bearing code :	UC313
Axis diameter d :	65
Dimensions (mm) :	
H :	90
L :	335
J :	260
A :	90
N :	25
N1 :	38
H1 :	33
Ho :	176
S :	30
B :	75
Bolt specifications :	M20
model :	UCP313
Seat code :	P313
weight :	
Kg :	11.3

介绍:

Outer spherical ball bearings are actually a variant of deep groove ball bearings, characterized by a spherical outer diameter surface on its outer ring, which can be fitted into the corresponding concave spherical surface of the bearing seat for centering.

It is mainly used to bear radial and axial combined loads, mainly radial loads. Generally, it is not suitable to bear axial loads alone. This type of bearing can be separately installed with an inner ring (with a full set of rollers and retainers) and an outer ring. This type of bearing does not allow the shaft to tilt relative to the housing, as it will generate additional axial force under radial load. The size of the axial clearance of this type of bearing is closely related to its normal operation. When the axial clearance is too small, the temperature rise is relatively high; When the axial clearance is large, the bearing is prone to damage. Therefore, special attention should be paid to adjusting the axial clearance of the bearing during installation and operation. If necessary, pre interference installation can be used to increase the rigidity of the bearing.