

Cylindrical roller bearing

Single row cylindrical roller bearings-**NJ206ETN1**

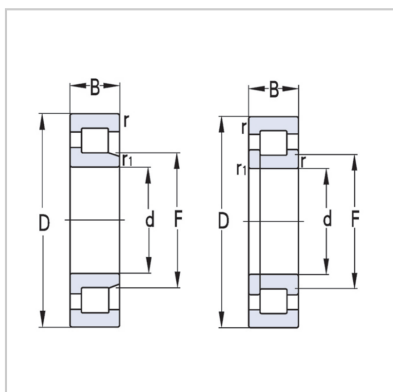
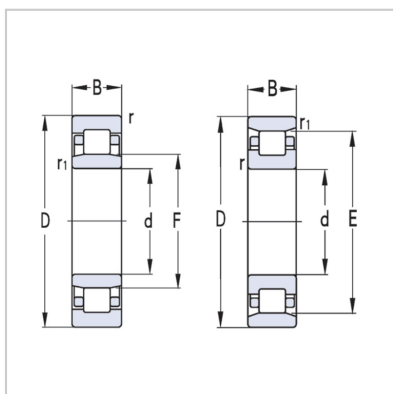

Bearing code : NJ206ETN1

Basic dimensions (mm) :

d :	30
D :	62
B :	16
rs min :	1
r1s min :	0.6
F :	37.5
E :	-

Basic rated load (KN) :

Cr :	39
Cor :	42

Extreme speed (r/min) :

grease :	9500
Oil lubrication :	12000

Installation related dimensions (mm) :

da(min) :	34
da(max) :	36
db(min) :	43
Da(max) :	57
Da(min) :	-
ra(max) :	1
rb(max) :	0.6
Weight (Kg) :	0.203

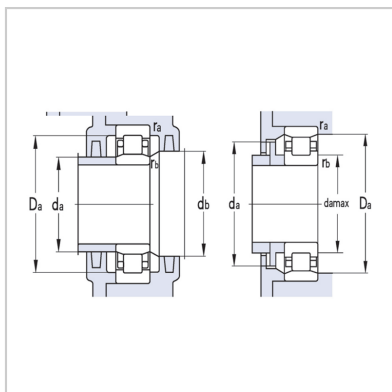

介绍:

Cylindrical roller bearings belong to separable bearings, with linear contact between the inner and outer rings and the rollers, low friction coefficient, and high ultimate speed. Double row cylindrical roller bearings have the advantages of compact structure, strong rigidity, high load-bearing capacity, and small deformation under load, and are used for machine tool spindle support. Cylindrical roller bearings are commonly used in heavy machinery such as cold and hot rolling mills. The basic type of radial clearance for single row cylindrical roller bearings is ordinary grade. Bearings with suffix C3, C4 or other clearance grades can be selected according to the actual situation.